

||||| **COBY**® |||||

TF-DVD7100

Please read this manual before and during use.



English

Important Safety Instruction

CAUTION: Use of controls or adjustments or performance of procedures other than those specified herein may result in hazardous radiation exposure.

Please carefully study this manual and always keep it available. There are, however, some installation and operation precautions which you should be aware of .

- (1) Read these instructions-All the safety and operating instructions should be read before the product is operated.
- (2) Keep these instructions-The safety and operating instructions should be retained for future reference.
- (3) Heed all warnings-All warnings on the product and in the operating instructions should be adhered to.
- (4) Follow all instructions-All operating and use instructions should be followed.
- (5) Do not use this apparatus near water-The apparatus shall not be exposed to dripping or splashing and that no objects filled with liquids, such as vases, shall be placed on the apparatus.
- (6) Clean only with dry cloth-Unplug this product from the wall outlet before cleaning. Do not use liquid or aerosol cleaners. Clean only with dry cloth.

Exception: A product that is meant for uninterrupted service and that for some specific reason, such as the possibility of the loss of an authorization code for a CATV converter, is not intended to be unplugged by the user for cleaning or any other purpose, may exclude the reference to unplugging the product in the cleaning description otherwise required in 131.8(5)

- (7) Do not block any ventilation openings. Install in accordance with the manufacturer's instruction-Slots and openings in the cabinet are provided for ventilation and to ensure reliable operation of the product and to protect it from overheating, and these openings must not be blocked or covered. The openings should never be blocked by placing the product on a bed, sofa, rug, or other similar surface. This product should not be placed in a built-in installation such as a bookcase or rack unless proper ventilation is provided or the manufacturer's instructions have been adhered to .
- (8) Do not install near any heat sources such as radiators, heat registers, stoves, or other apparatus (including amplifiers) that produce heat.
- (9) Do not defeat the safety purpose of the polarized or grounding-type plug. A polarized plug has two blades with one wider than the other. A grounding type plug has two blades and a third grounding prong. The wide blade or the third prong is provided for your safety. If the provided plug does not fit into your outlet, consult an electrician for replacement of the obsolete outlet.
- (10) Protect the power cord from being walked on or pinched particularly at plugs, convenience receptacles, and the point where they exit from the apparatus. Power-supply cords should be routed so that they are not likely to be walked on or pinched by items placed upon or against them, paying particular attention to cords at plugs, convenience receptacles, and the point where they exit from the product.
- (11) Only use attachments/accessories specified by the manufacturer. Do not use attachments not recommended by the product manufacturer as they may cause hazards.
- (12) Use only the cart, stand, tripod, bracket, or table specified by the manufacturer, or sold with the apparatus. When a cart is used, use caution when moving the cart/apparatus combination to avoid injury from tip-over.



- (13) Unplug this apparatus during lightning storms or when unused for long periods of time. Unplug it from the wall outlet and disconnect the antenna or cable system. This will prevent damage to the product due to lightning and power-line surges.
- (14) Refer all servicing to qualified service personnel. Servicing is required when the apparatus has been damaged in any way, such as power-supply cord or plug is damaged, liquid has been spilled or objects have fallen into the apparatus, the apparatus has been exposed to rain or moisture, does not operate normally, or has been dropped.
- (15) Power Sources- This product should be operated only from the type of power source indicated on the marking label. If you are not sure of the type of power supply to your home, consult your product dealer or local power company. For products intended to operate from battery power, or other sources, refer to the operating instructions.
- (16) Protective Attachment Plug-The product is equipped with an attachment plug having overload protection. This is a safety feature. See instruction manual for replacement or resetting of protective device. If replacement of the plug is required, be sure the service technician has used a replacement plug specified by the manufacturer that has the same overload protection as the original plug.
- (17) Outdoor Antenna Grounding- If an outside antenna or cable system is connected to the product, be sure the antenna or cable system is grounded so as to provide some protection against voltage surges and built-up static charges. Article 810 of the National Electrical Code, ANS/NFPA 70, provides information with regard to proper grounding conductors, location or antenna- discharge unit, connection to grounding electrodes, and requirements for the grounding electrode.
- (18) Power lines- An outside antenna system should not be located in the vicinity of overhead power lines or other electric light or power circuits, or where it can fall into such power lines or circuits. When installing an outside antenna system, extreme care should be taken to keep from touching such power lines or circuits as contact with them might be fatal.
- (19) Overloading- Do not overload wall outlets, extension cords, or integral convenience receptacles as this can result in a risk of fire or electric shock.
- (20) Object and Liquid Entry- Never push objects of any kind into this product through openings as they may touch dangerous voltage points or short-out parts that could result in a fire or electric shock. Never spill liquid of any kind on the product.
- (21) Servicing -Do no attempt to service this product yourself as opening or removing covers may expose you to dangerous voltage or other hazards. Refer all servicing to qualified service personnel.
- (22) Replacement Parts-When replacement parts are required, be sure the service technician has used replacement parts specified by the manufacturer or have the same characteristics as the original part. Unauthorized substitutions may result in fire, electric, or other hazards.
- (23) Safety Check- Upon completion of any service or repairs to this product, ask the service technician to perform safety checks to determine that the product is in proper operating condition.

Safety Precautions



The lightning flash with arrowhead symbol within an equilateral triangle is intended to alert the user to the presence of uninsulated "dangerous voltage" within the product's enclosure that may be of sufficient magnitude to constitute risk of electric shock to persons.

The exclamation point within an equilateral triangle is intended to alert the user to the presence of important operating and maintenance (servicing) instructions in the literature accompanying the product.

WARNING: To reduce the risk of fire or electric shock, do not expose this appliance to rain or moisture. Dangerous high voltage is present inside the enclosure. Do not open the cabinet.

CAUTION: To prevent electric shock, match wide blade plug to wide slot, and fully insert.

CAUTION: This Digital Video Disc Player employs a laser System. To prevent direct exposure to the laser beam, do not try to open the enclosure. When open and the interlocks are defeated, visible laser radiation is present.

Use of controls or adjustments or performance of procedures other than those specified herein may result in hazardous radiation exposure. **DO NOT STARE INTO BEAM.**

FCC NOTICE: This equipment has been tested and found to comply with the limits for a **Class B** digital device. Pursuant with the **FCC Rules, Part 15**. These limits are designed to provide reasonable protection against harmful interference in a residential installation.

This equipment generates, uses and can radiate radio frequency energy and if not installed and used in accordance with the instruction may cause harmful interference to radio communication.

Table of Contents

	Page
IMPORTANT SAFETY INSTRUCTIONS	
SAFETY INFORMATION	
TABLE OF CONTENTS	
UNPACKING.....	1
NOTE ON DISC.....	2
IDENTIFICATION OF CONTROLS.....	3-5
CONNECTIONS(Connecting to a TV).....	6
CONNECTIONS(Connecting to an amplifier equipped with a Dolby Pro Logic Surround).....	7
PREPARATIONS BEFORE OPERATION.....	8-10
PLAYING A DISC.....	11
FUNCTION BUTTONS.....	12-15
SETUP MENU.....	16
CUSTOM SETUP.....	17
TROUBLE SHOOTING.....	18
SPECIFICATIONS.....	19

Unpacking

Please make sure the following items are included with your DVD player. If any items are missing, contact your dealer.

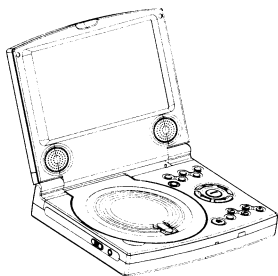

DVD Player

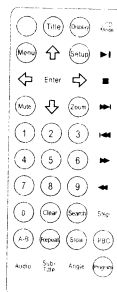

Remote Control

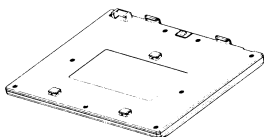

Battery

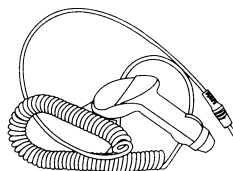

CD Car Cord

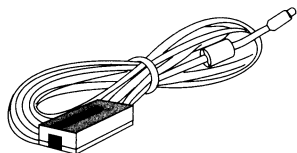

AC/DC Adapter

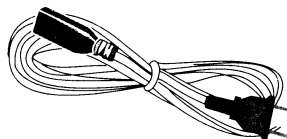

Power Cord

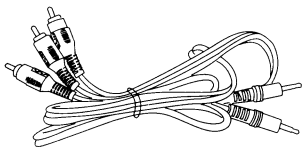

RCA Cable

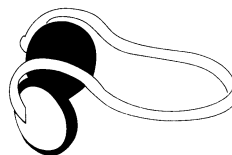



Headphones

Note on Disc

Disc Requirement

The DVD player can play back the following discs.

	Disc mark	Contents	Disc size	Maximum playback time
DVD video discs		Audio+Video (moving picture)	12cm	133 min (SS-SL)
				242 min (SS-DL)
				266 min (DS-SL)
484 min (DS-DL)				
Audio CDs		Audio	12cm	74min

In addition, this unit can play back a CD-R, or CD-RW that contains audio titles or MP3 files. You cannot playback discs other than those listed above. (CD-ROM, CD-Extra, CD-G, and CD-I discs can not be played on this DVD player.)

Care of Disc

Video disc contains high-density compressed data that needs proper handling.

Hold the disc with fingers. Hold the disc's outer edge and/or the center spindle hole.
Do not touch the disc surface.

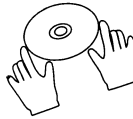

Do not bend or press the disc. Do not expose the disc to direct sunlight or heating sources.



Store discs in cabinet vertically, and in dry condition. Prevent exposure to :

- Direct sunlight
- Heat or exhaust from a heating device.
- Extreme humidity.

Clean the disc surface with a soft, dry cleaning cloth. Wipe the disc surface gently and radially from center toward the outer edge. Do not apply thinner, alcohol, chemical solvent, or sprays when cleaning. Such cleaning fluids will permanently damage the disc surface.

Identification of Controls

Main Unit

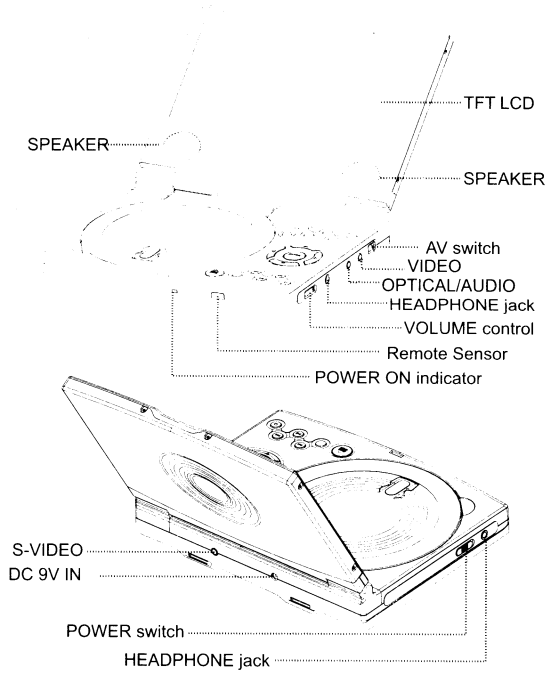

Identification of Controls

Main Unit

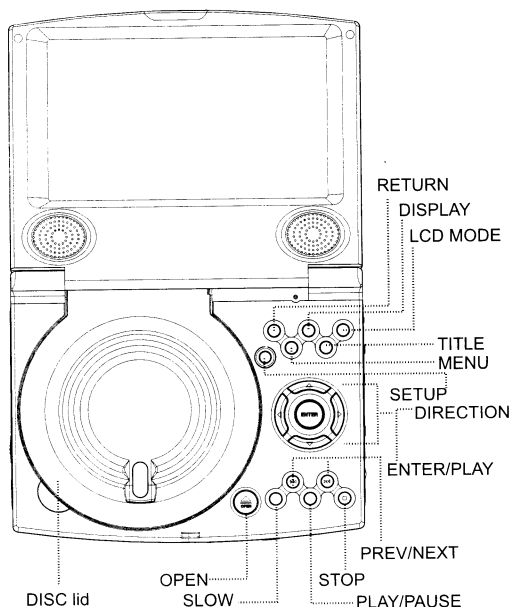

NOTE:

- For the first use, please remove the protective sheet from the TFT screen.
- Place a disc with label facing up, and push gently on the center of the disc so it goes into position.
- To start playing, press the ENTER button.
- To stop playing, press the STOP button.
- To Skip Forward/Skip Backward, press the PREV/NEXT ►/◄.
- To Fast Forward/Fast Backward, press and hold the PREV/NEXT button for about two seconds.
- Power ON LED status:
 - a). It is green under normal playback.
 - b). It is red under STANDBY mode.

Identification of Controls

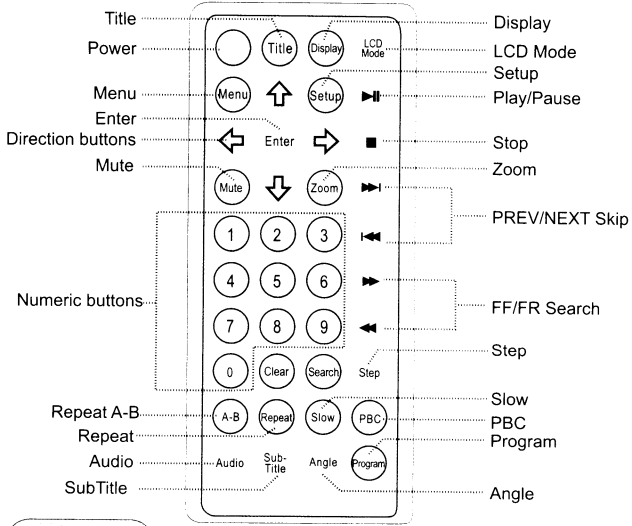

Remote Control

Connections

Connecting to a TV set

If the TV has a S-video input, connect the DVD player with a S-video cable. Do not connect more than one video connection at a time to avoid picture interference.

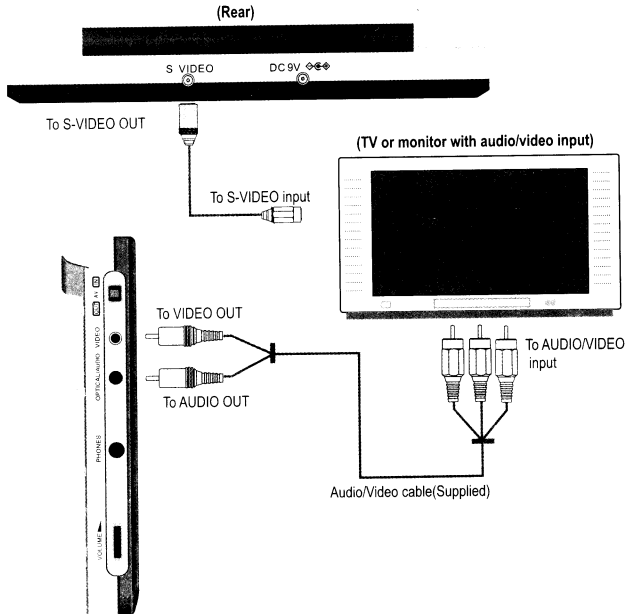

NOTE:

1. Refer to the owner's manual of your TV as well.
2. Before connecting the DVD player to a TV set, be sure to turn the power off and unplug both units from the wall outlet.

Connections

Connecting to an amplifier equipped with a Dolby Pro Logic Surround with optical input

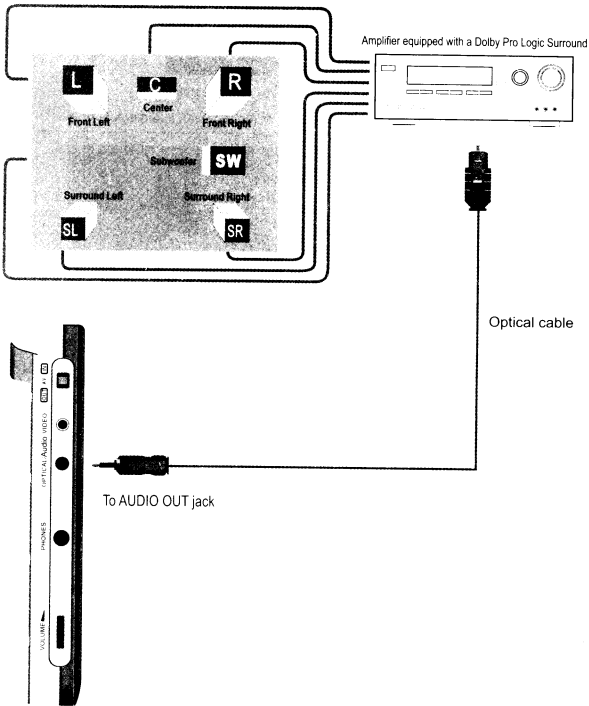

With a receiver equipped with Dolby Digital
Connect the equipment. Refer to receiver's owner's manual.

Preparations before Operation

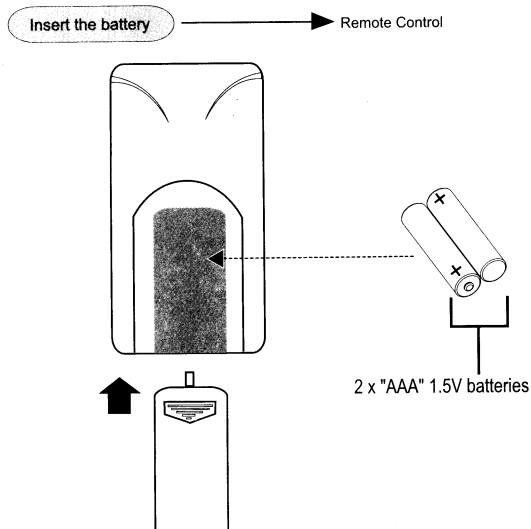

Note:

1. Refer to the diagram. Open the battery compartment of the remote control. Insert batteries, then close the compartment.
2. To use the remote control, point it at the remote sensor of the unit and operate in the range of 5 meters and at angle of 60°.
3. Generally, the batteries last for about one year. Replace the batteries if the remote control does not work.
4. Remove the batteries if remote control will not be in use for a long period of time.

Warning: The battery used in this device may present a fire or chemical burn hazard if mistreated. Do not recharge, disassemble, incinerate, or heat about 100°C(212°F)
Use of another battery may present a risk of fire or explosion. Dispose of used batteries. Keep batteries away from children. Do not disassemble or dispose of fire.

Preparations before Operation

Power Connections

→ AC Adapter

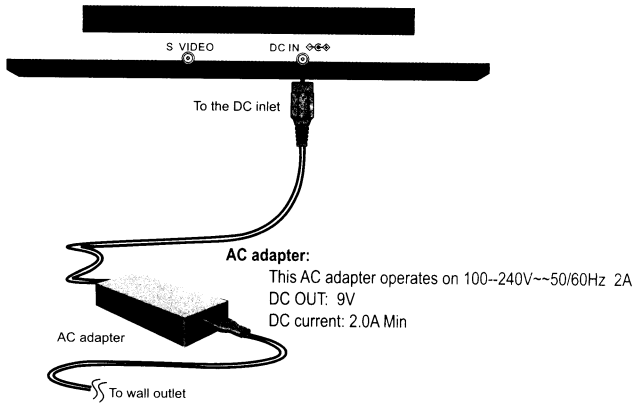

Caution:

Do not connect the power plug to a power outlet other than that indicated on the label, as this can result in a risk of fire or electric shock.

Do not connect or disconnect the power plug with wet hands. Doing so may cause electric shock.

Do not use an AC adapter other than one specified, as it can cause a fire or damage to the player.

Preparations before Operation

Power Connections

→ Battery Pack

For new or exhausted rechargeable battery pack, we recommend it be charged for 4 hours.

Attaching the battery pack

1. Match the hooks of the battery pack into the holes on the rear of the player.
2. Press and slide the battery pack until the hooks click.

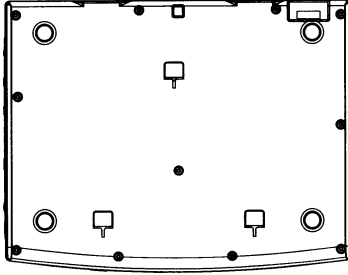

Li-ion Polymer Rechargeable Battery pack
7.4V 3000mA/h

* The battery pack can be recharged for about 300 times without obvious performance dropped.

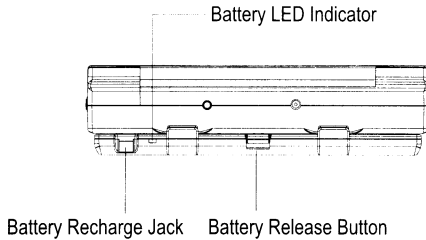

* When the battery pack is connected, you can insert the AC adapter to either the DC in jack or the battery recharge jack for both playing and charging.

When in charging, the battery LED indicator is red. And it will turn to green after fully charged.

NOTE: When battery voltage reaches low, the unit will access to STANDBY mode automatically.

Playing a Disc

Basic Playback

Prepare the power supply.

1. Open the cover of the DVD player by hand.

Slide the **POWER** switch to the left to turn the unit on.

The COBY Logo picture appears on screen after 2-3 seconds turning on the unit.

2. Load a disc

Press OPEN  button to open the disc lid and insert a disc with the label up.

Close the disc lid by hand.

- If the single sided disc is placed in upside down, "NO DISC" or "BAD DISC" will appear on the TV screen.
- After playing back all of the chapters in the title, the DVD player stops automatically and shows the menu screen.

3. Start playback

Press PLAY button to start playing. (Some discs may play automatically).

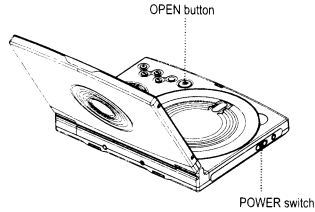

If a DVD disc menu appears on screen



Press the DIRECTION buttons to select the desired feature in the menu.
Press ENTER button to confirm a selection in the menu.

4. Adjust the volume

Turn the volume control on main unit to the desired volume level.

Problem disc messages

The following message will be displayed on screen when there is a format problem with loaded disc:

"WRONG REGIONAL DISC"

Region code of the disc is not matching to the player's (region 1 to region 6)

"WRONG PASSWORD"

The rating level of the disc is higher than the rating level setting of the player.
The player will not play the disc.

"WRONG DISC"

The player is equipped with automatic disc quality detection software. When the player detects a problem or damaged disc, the unit may play the disc at a lower quality or stop completely, depending on the damaged level of the disc.

Production qualities of DVD discs vary. Some discs may deviate from the industry standard. Some incorrectly formatted discs may be played. However, the playback and operational quality may be substandard.

POWER management

If the player will not be in use for a long period of time, please push power switch to **OFF** position.

Function Buttons

LCD Mode

To adjust the Brightness, Contrast, and Color of the TFT panel.

 Press the LCD Mode button, the screen shows:

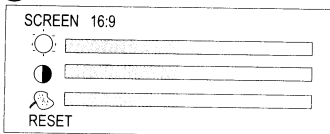

Press LCD Mode button repeatedly to select the desired item, and adjust by the LEFT/RIGHT button.

When the SCREEN is selected, press LEFT/RIGHT button to select 16:9 or 4:3

When the RESET is selected, the three items will be reverted to default settings.

Display

 Press Display button to show the time and status information.

Press Display button the third time to quit the display mode.

Under AV IN mode (Slide the AV switch to IN position), press the Display button to shift the TV SYSTEM between NTSC and PAL.

Play/Pause/Stop

 Press Play button for the first time to play the disc.

Press the button for the second time to pause playing. (Still picture).

Press again to resume playback.

 Press the STOP button once, to stop playback. Press the PLAY button to resume. Disc will begin playing from where it was stopped.

Press the STOP button twice, to stop playback. Press the PLAY button to resume. Disc will begin playing from the beginning.

Skip Forward/Backward

 Press the button to skip advance DVD chapter or CD track

 Press the button to skip backward DVD chapter or CD track

NOTE: Player will not skip forward or backward during "WARNING" section of a DVD disc.

Single chapter DVD or single track CD cannot be skipped.

Fast Forward/Backward

 Press the button to fast forward through the disc. Repeatedly pressing the button will increase the search speed.

Normal → x2 → x4 → x8 → x16 → x32

 Press the button to fast backward through the disc. Repeatedly pressing the button will increase the search speed.

Press PLAY to resume normal playback.

NOTE: The player is muted in fast forward or fast backward mode.

The player will not fast forward or fast backward during WARNING section of a DVD disc.

Slow

 Press SLOW button to play at slow motion. Repeatedly pressing the button will decrease the slow speed.

Normal → x1/2 → x1/4 → x1/8 → x1/16 → x1/32

NOTE: The player is muted at SLOW mode.

Function Buttons

Disc MENU/TITLE



 While playing a DVD, press the MENU button to return to the DVD disc start menu.

 While playing a DVD, press the TITLE button to return to the beginning of the Title menu.

NOTE: Some DVD discs do not allow the TITLE function.

Select an item in the menu

In the DVD disc start menu or in the Set Up menu

 Enter  Press DIRECTION buttons to highlight function icons.
Press ENTER button to confirm a selection.



 Press CLEAR button to cancel an entry.

Press the RETURN button on main unit to return to the upper level menu.

Numeric Key Pad

(Random Program access)

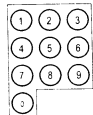
 1.) To directly access a DVD Chapter or a CD track, input the desired DVD Chapter or CD Track number using the numeric key pad.
2.) Input data for the DVD disc start menu or the player's setup menu.

NOTE: Some DVD discs do not allow direct access function.

MUTE

 Press MUTE button to select mute on or mute off.

ZOOM

PLAYING DVD
 Press the ZOOM button repeatedly and the TV screen will display:
ZOOMx2 → ZOOMx4 → ZOOMx1

PLAYING JPEG
Press the ZOOM button repeatedly and the TV screen will display:
25% → 50% → 100% → 150% → 200%

While at 100%, press the direction button to rotate the picture.

While at 150% or 200%, press the direction button to move the picture position.

NOTE: The picture quality decreases as the picture size increases.

Search

 Go to a desired section. (A desired Title, chapter, Time or Track)

Function Buttons

In DVD mode

Pressing the Search button once appears:

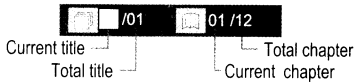

Pressing the Search button twice appears:

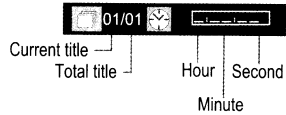

Press Right/Left button to select the desired item, and input desired Title, Chapter, Time or Track by the numeric button.

Press Play button to execute the search, or press Search button for the third time to quit the Search menu.

NOTE: Some DVD and MP3 discs do not allow the Search function during program playing.

Repeat Section A-B

To repeat playback a specific section of a disc.

Press the A-B button at the starting point of the desired section. "Repeat A" appears on screen.

Press the A-B button again at the end of the desired section. "Repeat A-B" appears on screen.

The player will start repeating playback the selected section from A to B until the function is cancelled.

To cancel the function, press the A-B button for the third time to return to normal playback.

NOTE: Some DVD discs do not allow the A-B function playback. This function does not apply to MP3 discs.

REPEAT

This function allows repeated playback of a Title, Chapter or Track.

Press REPEAT button repeatedly to select the repeat mode.



In DVD mode	
↔ CHAPTER	Repeat chapter
↔ TITLE	Repeat title
↔ DISC	Repeat all disc
↔ OFF	Repeat off

In CD/MP3 mode	
↔ TRK	Repeat track
↔ DISC	Repeat disc
↔ OFF	Repeat off

NOTE: Some DVD discs do not allow REPEAT function.

STEP



Press STEP when playing, it can step frame by frame.

Press PLAY button to quit the STEP mode.

Multi-Angle/Subtitle/Audio



While playing a DVD disc, press ANGLE button to view different camera angles on the disc.

A DVD disc may contain up to 9 selectable camera angles.



While playing a DVD disc, press Sub-Title button to select the language of the viewable subtitle.

A DVD disc may contain up to 32 selectable subtitles.

Function Buttons



While playing a DVD disc, press AUDIO button to select the language of the audio sound track. A DVD disc may contain up to 8 selectable audio sound tracks.

NOTE: Some DVD discs do not have multiple ANGLES, SUBTITLES or AUDIO features.

SETUP



Press the SETUP button to enter the player's setup menu.

The SETUP menu allows the viewer to adjust the setting details of the DVD player.

Please read the "SETUP menu" of the manual for further directions on how to use the SETUP menu.

PROGRAM

To program play a disc in a desired sequence.

NOTE: The Program function is available just as the player is in Navigate Off mode.

Press the PBC button to set Navigate Off.



Press Program button to enter the program menu.

In DVD mode

- When the Program menu appears, select the Title by UP/DOWN button and press ENTER.
- Select the Chapter by UP/DOWN button and press ENTER.
- Repeat step a to b to set up to 20 titles for the programming playback.
- Press PLAY to start playing the programmed titles.

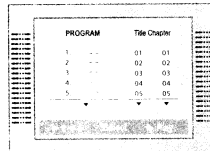

In CD mode

- When the Program menu appears, select the Track by UP/DOWN button and press ENTER.
- Repeat Step a to set up to 20 tracks for the programming playback.
- Press PLAY to start playing the programmed tracks.

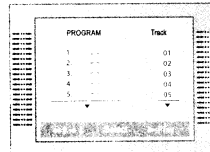

In MP3 mode

- When the Program menu appears, press the ▲\▼ button to select the folder, use the ENTER button to confirm.
- Highlight the desired track by the ▲\▼ button, and press the RIGHT button to select it. (The tracks to be programmed playback can be in different folders. Press the LEFT button to return to the folder menu).
- Repeat Step a to b to select the tracks you wish to play.
- Press PLAY to start playing the programmed tracks.

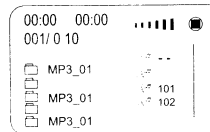

For your reference:

- To cancel the incorrect input information, press the Clear button.
- Press Program again to quit the program menu.
- Under program playing, press the Program twice to resume normal playback.

NOTE: Some discs do not allow program setting.

Setup Menu

Various features of the DVD player can be adjusted in the SETUP menu.

1. Press SETUP button, then the SETUP menu appears on screen.
2. Press the UP/DOWN button to highlight the desired menu.
3. Press ENTER button to confirm your selection.
4. Press SETUP button again to quit the SETUP menu.

NOTE:

Make sure the player is in STOP mode before setting the SETUP menu.

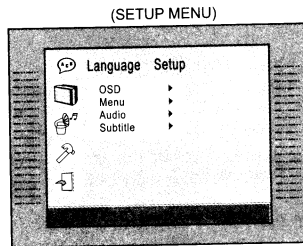

Language Setup

Press the Direction keys to highlight the desired LANGUAGE item.

Item	Instruction	Default setting
OSD	To select the language of the OSD.	English
Menu	To select the language of the Menu.	English
Audio	To select the language of the audio sound track	English
Subtitle	To select the language of the subtitle. When OFF is selected, the subtitle will not be displayed.	English

Screen Setup

Press the Direction keys to highlight the desired SCREEN item.

Item	Instruction	Default setting
TV Type	To select the TV screen size from: 4:3 PS (Pan Scan); 4:3 LB (Letter Box); 16:9 (Wide Screen)	16:9
Screen Saver	To set Screen Saver function ON or OFF.	OFF
TV System	To select the TV system from: NTSC; PAL; AUTO	NTSC
Brightness	To select the brightness from: Normal; Bright; Soft	NORMAL
Contrast	To select the contrast level from: -4; -3; -2; -1; 0; 1; 2; 3; 4	0

NOTE:

- Certain DVD discs are formatted in wide screen (16:9) or letter box (4:3) only. Adjusting the setting of the disc player will not change the screen size for these "Format-only" discs.
- The TV system for North America is NTSC. Auto should only be used if you have a Multi-System TV.

Audio Setup

Press the Direction keys to highlight the desired Audio item.

Item	Instruction	Default setting
Digital Out	To select the digital output from: SPDIF/PCM; SPDIF/RAW; OFF	SPDIF/RAW

NOTE:

When Digital Out is NOT in use, it is recommended to turn OFF the digital output setting, for the purpose of minimizing the circuit interference.

Custom Setup

Press the direction keys to highlight the desired Custom item. (Parental Ctrl, Password, Angle Mark, Default)

A). Parental Ctrl

- There are eight levels of Parental Control. Level one opens discs to people of all ages. Level eight is suitable only for adults.
- To change the parental control setting, a 4-digit code is required to be input first. (The default code is 8888.) When the input code is confirmed, the level setting menu will appear. Select the appropriate level by the UP/DOWN button, and press ENTER to confirm.

B). Password

Move the cursor to the PASSWORD prompt and press ENTER. Input the password 8888 if it is the first use. After confirmation, you will be required to input a new 4-digit code, and verify again.

WARNING:

- Please keep a copy of the new password in a safe place. Otherwise, you will not be able to change the Parental Control.
- Please remember your password, as the DEFAULT setting will revert everything BUT the PASSWORD to the factory defaults.

C). Angle Mark

Choose between ON and OFF.

When the Angle Mark function is ON, an icon will be displayed on screen if the disc has multiple angle shots available for viewing.

Press ANGLE on the remote control to enjoy these scenes.

D). Default

This function allows you to change the player back to the factory default settings. All settings will be changed back to the original settings except the Password.

Trouble Shooting

Should your DVD player develop a problem, please check below before requesting service:

Symptom	Check and Action
No power	<ol style="list-style-type: none"> 1. Make sure the unit has been powered on manually. 2. Check if the power cord has been properly connected to the power outlet. 3. Make sure the battery pack is fully charged.
Does not play	<ol style="list-style-type: none"> 1. No disc, load a disc. 2. Disc has been loaded upside down. Place the disc with the label side up. 3. Disc's rating level is higher than the player's setting. 4. Disc is incorrect type for the player. 5. Disc is damaged or dirty. Clean the disc or try another one. 6. Moisture may be condensed inside the player. Remove the disc and leave the unit power on for one or two hours.
No Picture	<ol style="list-style-type: none"> 1. Check if the TV set has been powered on. Use TV remote to select AV signal for DVD rather than broadcast. 2. Check if the system connection is proper and secure. 3. Check if the connection cables are damaged. 4. Clean the disc.
Picture noisy/ distorted	<ol style="list-style-type: none"> 1. Disc is damaged or dirty. Clean the disc or try another one. 2. Reset the color system of the TV set. 3. Make sure the DVD player is not connected through a VCR, cable or satellite dish.
No sound or sound output not complete	<ol style="list-style-type: none"> 1. Check if the TV and amplifier have been switched on and correctly set. 2. Check if the TV and amplifier system connections are secured. 3. Press AUDIO button to select other audio tracks of the disc. 4. Check if the MUTE function of the TV or amplifier has been activated. 5. There will be no sound output during REVERSE PLAY/PAUSE/SLOW and SEARCH.
Remote control does not work	<ol style="list-style-type: none"> 1. Make sure the POWER button on the unit has been turned on manually. 2. Remove the obstacles between the remote control and the player. 3. Point the remote control towards the remote sensor on the player. 4. Check if the batteries of the remote control have been loaded with correct polarities. 5. Replace the batteries of the remote control.
Malfunction	<p>Should the player develop a malfunction, unplug the player for 30 minutes. After that, power on the player and the restore function should reset the player.</p>

Specification

Power supply	DC 9.0V 2A (AC adapter TERMINAL)
Power consumption	≤ 9.8W
Signal system	NTSC / PAL
Video output	1±0.2V (p-p), 75ohm, negative sync., 3.5 mm mini jack x1
S-video output	(Y) 0.7 ±0.14V (p-p), 75 ohm, negative sync. (C) 0.88±0.176V(p-p), 75 ohm
Audio output	1.5 Vrms (1 KHz, 0dB), 3.5 mm mini jack x1
Earphone terminal	3.5mm stereo mini jack x2
Signal /Noise ratio(audio)	90dB typical
Dynamic range(audio)	90dB typical
Panel size	7 inch (16:9)
Resolution	480 X 234 pixels
Laser	Wavelength 650 nm
Operating conditions	Temperature: 0 c to 35` c. Operation status : Horizontal
Dimensions	194 x152x30 mm (main unit)
Weight	993g (main unit)